



T-GAGE M18T 類比輸出紅外線溫度感測器

18mm感測器帶有0~10V類比輸出及教導設定模式

February 2006



型號*	接線	D:S 比率	鏡頭 檢測面	供電電壓*	輸出型式
M18TUP8	5-wire, 2 m (6.5') shielded cable	8:1	整體式 鏡頭	12 to 30V dc	0 to 10V dc analog, plus PNP Alarm
M18TUP8Q	5-pin, Euro-style integral QD				
M18TUP6E	5-wire, 2 m (6.5') shielded cable	6:1	塑料包覆 鏡頭表面 (食品工業 使用)		
M18TUP6EQ	5-pin, Euro-style integral QD				
M18TUP14	5-wire, 2 m (6.5') shielded cable	14:1	鍍鏡頭		
M18TUP14Q	5-pin, Euro-style integral QD				

* 產品型號帶有 5 芯, 2m (6.5') 屏蔽電纜線, 或 5-腳 QD Euro-型整體式電纜, QD型號字尾加註"Q"。型號後加註"W/30"電纜長度為 9 m (30')。

Development Strategy

邦納在現有類比控制設備中推陳出新, 為了滿足市場上對於簡易, 低價位及功能強大的類比溫度感測器的需求, 推出了M 18類比溫度感測器。此帶電壓型的感測器是為基於工廠技師們的需求而被推薦的首選感測器。

Features

- 75 ms 快速響應時間
- 簡易教導設定, 無電位器調整
- 精巧, 內藏型外殼, 無需外部控制器
- 檢測時產品不需移動
- 遠程教導可設定靜態及動態教導
- 警告輸出可顯示信號最大值
- 可編輯類比正斜率及負斜率輸出: 感測器在第一個溫度設定點為0V, 第二個溫度設定點為10V。在此區段自動形成線性變化, 最小教導溫差10° C。

Applications

- 高溫物件偵測, 包括烘烤物體, 金屬, 玻璃及塑料容器, 橡膠彎曲及成型
- 高溫物體 "彎曲成型" 控制
- 銲接製程確認
- 熱膠塗佈監測
- 高溫密封監測
- 低溫物件偵測, 包括冷凍食品, 冰淇淋, 乳製品, 冰冷滾筒
- 設備溫度監控 (失效預先警告), 譬如: 高溫齒輪箱或馬達
- 表面溫度監控



more sensors, more solutions

T-GAGE™ M18T Series Infrared Temperature Sensors

18 mm sensor with 0-10V analog output and TEACH-mode programming

Features



- Fast 75 ms response time
- Easy-to-use TEACH mode programming; no potentiometer adjustments
- Small self-contained package, no auxiliary controller needed
- Rugged encapsulated design for harsh environments
- Choose 2 meter or 9 meter unterminated cable, or 5-pin Euro-style QD connector
- Product motion not required for sensing
- Remote Teach available in both Static and Dynamic modes
- Alarm output for signal maximum
- Programmable for either positive or negative analog slope based on teach order

Models

Model	Cable*	D:S Ratio	Sensing Face	Supply Voltage	Output
M18TUP8	5-wire, 2 m (6.5') shielded cable	8:1	Integrated lens	12 to 30V dc	0 to 10V dc analog, plus PNP Alarm
M18TUP8Q	5-pin, Euro-style integral QD				
M18TUP6E	5-wire, 2 m (6.5') shielded cable	6:1	Enclosed Plastic face (for food industry use)		
M18TUP6EQ	5-pin, Euro-style integral QD				
M18TUP14	5-wire, 2 m (6.5') shielded cable	14:1	Germanium lens		
M18TUP14Q	5-pin, Euro-style integral QD				

*For 9 m (30') cable, add suffix "W/30" to the model number of any cabled model (e.g., M18TUP8 W/30). A model with a QD connector requires an accessory mating cable. See page 7 for more information.



WARNING . . . Not To Be Used for Personnel Protection

Never use these products as sensing devices for personnel protection. Doing so could lead to serious injury or death. These sensors do NOT include the self-checking redundant circuitry necessary to allow their use in personnel safety applications. A sensor failure or malfunction can cause either an energized or de-energized sensor output condition. Consult your current Banner Safety Products catalog for safety products which meet OSHA, ANSI and IEC standards for personnel protection.

T-GAGE™ M18T Series Temperature Sensors – Analog Output

Overview

The T-GAGE analog sensor is a passive, non-contacting, temperature-based device. It is used to detect object(s) temperature within a sensing window and output a proportional voltage.

While it looks and operates just like an *Expert™* photoelectric sensor, the T-GAGE detects the infrared light energy emitted by objects, instead of its own emitted light. The sensor uses a thermopile detector, made up of multiple infrared-sensitive elements (thermocouples) to detect this infrared energy within its field of view (see Figure 2).

Potential applications include:

- Hot part detection (baked goods, metals, bottles, rubber)
- Ejection verification of injection-molded parts
- Flame process verification
- Hot glue detection (packaging equipment, book binding, product assembly)
- Cold part detection (frozen foods, ice, dairy)
- Roller monitoring

NOTE: The T-GAGE M18T sensor is not intended for absolute temperature measurement or for safety-related fire detection use.

Sensing Field of View

The sensing range is determined by the sensor's field of view (FOV), or viewing angle, combined with the size of the object(s) being detected (see Figure 2). The sensor's distance-to-spot size ratio (D:S ratio) is inversely related to the viewing angle; a sensor with a small viewing angle will have a large D:S ratio. The T-GAGE M18T sensors have D:S ratios of 6:1, 8:1 or 14:1. For a sensor with an 8:1 D:S ratio, the sensor's spot size is a 1" diameter circle at a distance of 8"; farther from the sensor face the spot size will be larger.

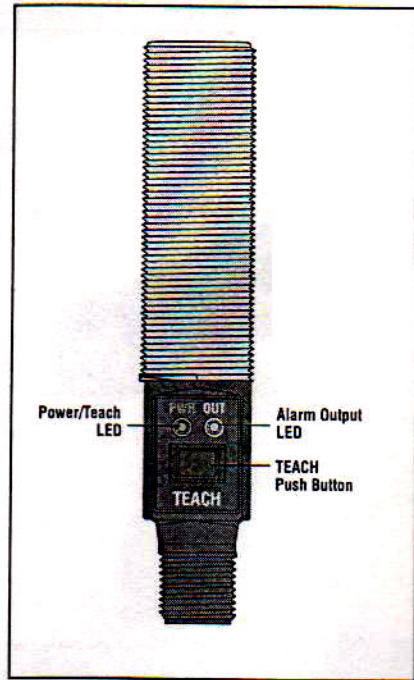

Figure 1. Sensor features

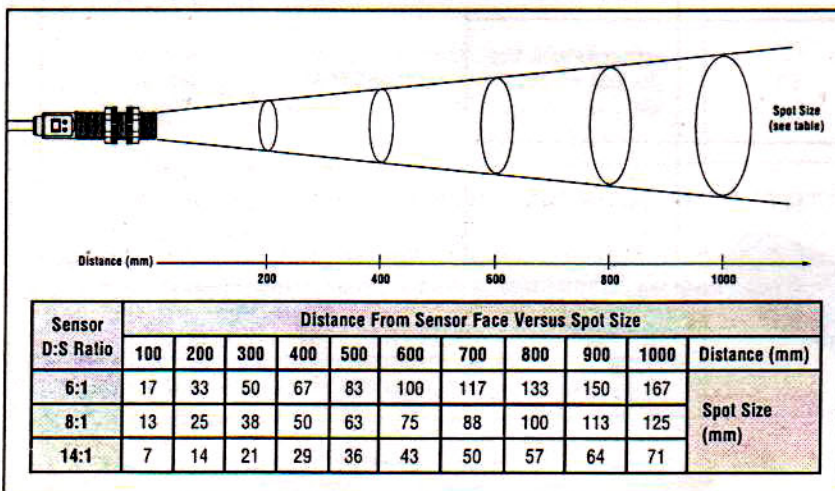

Figure 2. Detection spot size versus distance from sensor

T-GAGE™ M18T Series Temperature Sensors – Analog Output

Apparent Temperature

Two factors that have a large influence on apparent temperature are the object's *emissivity* and whether or not the object fills the sensor's field of view.

Object Emissivity: A "blackbody" is a "perfect" emitter, with an emissivity of 1.0 at all temperatures and wavelengths. Most surfaces emit only a fraction of the amount of thermal energy that a blackbody would. Typical T-GAGE applications will be sensing objects with emissivities ranging from 0.5 to 0.95. Many references are available with tables of emissivity coefficients for common materials. In general, shiny unpainted metals have low emissivity, while non-glossy surfaces have high emissivity. **Shiny surfaces:** a mirror or shiny surface can redirect an object's emitted energy to an undesired location, or even bring additional unintended thermal energy into the sensor's field of view (see page 6).

Object Size: If the object being detected does not fill the sensor's field of view, then the sensor will average the temperature of that object and whatever else is in the sensing field of view. For the sensor to collect the maximum amount of energy, the object should completely fill the sensor's field of view. However, in some applications, when the object is too small, this may not be possible. In such cases, if the object is hot enough, the thermal contrast may still be adequate to trigger the sensor's output.

Analog Output

The T-GAGE analog sensor can be programmed for either positive or negative output slope, based on the teach order (see Figure 3). If the cold limit is taught first, the slope will be positive; if the hot limit is taught first, the slope will be negative. Banner's scalable output automatically distributes the output signal over the width of the programmed sensing window.

Alarm Output

The alarm output will activate when the analog output is at 10V (see Figure 3).

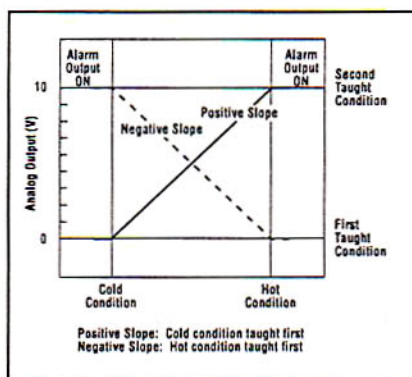

Figure 3. Analog/Alarm outputs as a function of taught conditions

Sensor Programming

Two TEACH methods may be used to program the sensor:

- Teach individual minimum and maximum limits (Two-Point Static Teach), or
- Dynamic Teach for on-the-fly programming.

The sensor may be programmed either via its push button, or via a remote switch. Remote programming also may be used to disable the push button, preventing unauthorized personnel from adjusting the programming settings. To access this feature, connect a normally open switch between the sensor's gray wire and dc common or connect the gray wire to a digital input (PLC).

NOTE: The impedance of the Remote Teach input is 3 k .

Programming is accomplished by following the sequence of input pulses (see programming procedures starting on page 4). The duration of each pulse (corresponding to a push button "click"), and the period between multiple pulses, are defined as "T":

$$0.04 \text{ seconds} < T < 0.8 \text{ seconds}$$

T-GAGE™ M18T Series Temperature Sensors – Analog Output

Status Indicators

Power ON/OFF LED	Indicates
OFF	Power is OFF
ON Green	Sensor is in Run mode
ON Red	TEACH is active







Alarm Output LED	Indicates
OFF	Run Mode: Alarm output is OFF TEACH Mode: Waiting for 10V (Span) condition
ON Yellow	Run Mode: Alarm output is energized TEACH Mode: Waiting for 0V (Null) condition
Flashing Yellow	Dynamic TEACH active

Teaching Limits Using Two-Point Static TEACH

Two-Point TEACH is the traditional setup method, used when two conditions can be presented individually by the user. The sensor establishes the 0V output condition with the first taught condition and the 10V output condition with the second taught condition, and it scales between these points.

General Notes on Programming

- The sensor will return to RUN mode if the first TEACH condition is not registered within 60 seconds.
- After the first limit is taught, the sensor will remain in PROGRAM mode until the TEACH sequence is finished.





	Two-Point TEACH Procedure		Result
	Push Button	Remote Line 0.04 sec. < T < 0.8 sec.	
Programming Mode	<ul style="list-style-type: none"> • Push and hold push button for 2 seconds 	<ul style="list-style-type: none"> • No action required 	<ul style="list-style-type: none"> • Power LED turns Red • Alarm LED turns ON
Learn 0 Volt Condition	<ul style="list-style-type: none"> • Present condition for 0V output and "Click" the push button 	<ul style="list-style-type: none"> • Present condition for 0V output • Single-pulse the remote line 	<ul style="list-style-type: none"> • Alarm LED turns OFF
Learn 10 Volt Condition	<ul style="list-style-type: none"> • Present condition for 10V output and "Click" the push button 	<ul style="list-style-type: none"> • Present condition for 10V output • Single-pulse the remote line 	<p>Teach Accepted</p> <ul style="list-style-type: none"> • Power LED turns Green • Sensor automatically sets the analog range and returns to Run mode <p>Teach Unacceptable</p> <ul style="list-style-type: none"> • Sensor returns to beginning of Teach
Exit Without Save	<ul style="list-style-type: none"> • Push and hold push button for 2 seconds 	<ul style="list-style-type: none"> • Hold remote line low for 2 seconds 	<ul style="list-style-type: none"> • Sensor returns to Run mode without saving new settings

T-GAGE™ M18T Series Temperature Sensors – Analog Output

Teaching Limits Using Dynamic TEACH

Dynamic TEACH is a method of setting the sensor's limits while the application is active. Dynamic TEACH will sense the high and low temperature limits of the process and automatically set the analog range between these limits.

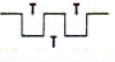
The output slope will remain in the direction of the most recently taught Two-Point Static TEACH or default to positive.

	Dynamic TEACH Procedure		Result
	Push Button	Remote Line 0.04 sec. < T < 0.8 sec.	
Programming Mode	<ul style="list-style-type: none"> Push and hold push button for 2 seconds 	<ul style="list-style-type: none"> No action required 	<ul style="list-style-type: none"> Power LED turns Red Alarm LED turns OFF
Enter Dynamic TEACH Process	<ul style="list-style-type: none"> "Double-click" push button 	<ul style="list-style-type: none"> Double-pulse the remote line 	<ul style="list-style-type: none"> Sensor begins dynamic learning process Alarm LED flashes Yellow @ 2 Hz
End Dynamic TEACH Process	<ul style="list-style-type: none"> "Single-click" push button 	<ul style="list-style-type: none"> Single-pulse the remote line 	<ul style="list-style-type: none"> Sensor ends data collection; sets 0V and 10V limits Power LED turns Green Sensor returns to Run mode

Changing Direction of Output Slope

The following procedure changes the direction of the analog output slope from negative to positive or from positive to negative. See page 3 for an explanation of the analog output slope.

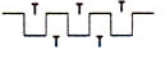
	Procedure		Result
	Push Button	Remote Line 0.04 sec. < T < 0.8 sec.	
Change Output Slope Direction	<ul style="list-style-type: none"> Not available via push button 	<ul style="list-style-type: none"> Triple-pulse the remote line 	<ul style="list-style-type: none"> Output slope changes to opposite of previous setting

Push Button Lockout

The push button lockout feature enables or disables the push button to prevent unauthorized adjustment of the program settings.

	Procedure		Result
	Push Button	Remote Line 0.04 sec. < T < 0.8 sec.	
Enable/Disable Push Button	<ul style="list-style-type: none"> Not available via push button 	<ul style="list-style-type: none"> Four-pulse the remote line 	<ul style="list-style-type: none"> Push button is either enabled or disabled, depending on previous condition.

T-GAGE™ M18T Series Temperature Sensors – Analog Output

Installation Notes

Align the sensor toward the object to be detected. Visually align if possible, or use the alignment device accessory listed on page 8.

Specifications

Temperature Measurement Range	0° to 300° C (32° to 572° F) standard; custom ranges available
Sensing Range	Depends on object size and sensing field of view (see page 2)
Wavelength	8 to 14 μm
Distance to Spot Size (D:S) Ratio	8:1, 6:1, or 14:1, depending on model
Supply Voltage	12 to 30V dc (10% maximum ripple); 35 mA max (exclusive of load)
Output Configuration	Analog: 0-10V Alarm: PNP (current sourcing)
Output Protection	Protected against short circuit conditions
Output Ratings	Analog: 2.5 kΩ minimum load resistance Alarm: Off-state leakage: < 10 microamps Saturation: < 1.2 V @ 10 mA and < 1.6V @ 100 mA
Output Response Time	75 ms (for a 95% step change)
Delay at Power-Up	1.5 seconds
Repeatability	± 1% of measurement, or ± 1° C, whichever is greater
Minimum Taught Differential	10° C
Linearity	From 0° to 50°C: ±2° C From 50° to 300°C: ±1° C or ±1%, whichever is greater
Adjustments	TEACH-Mode programming
Indicators	One bicolor (Green/Red) status LED, one Yellow LED (see page 4)
Remote Teach Input	Impedance: 3 kΩ minimum load resistance
Construction	Threaded Barrel: 304 stainless steel Push Button Housing: ABS/PC Push Button: Santoprene Lightpipes: Acrylic
Operating Conditions	Temperature: -20° to +70° C (-4° to 158° F)
Environmental Rating	Leakproof design is rated IEC IP67; NEMA 6
Temperature Warm-Up Time	5 minutes

Application Note

Following are examples of materials with high and low emissivity. (Many more examples can be found in sources such as the Internet.)

Sensor-Friendly Materials (High Emissivity)

Aluminum – anodized
Asphalt
Brick
Carbon – lampblack or plate material
Cardboard – corrugated or chipboard
Concrete
Glass – smooth, lead, or borosilicate
(e.g., Pyrex®)

Gypsum (including finished boards)
Ice
Iron and steel (except bright galvanized)
Paper – most types, regardless of color
Styrofoam® insulation
Plastics
Water
Wood – most types
Rubber (e.g., tires)

Materials to Sense with Caution (Low Emissivity – Test, Test, Test!)

Aluminum – plain or highly polished
Copper
Galvanized iron
Stainless steel
Vapor-deposited materials

T-GAGE™ M18T Series Temperature Sensors – Analog Output

Dimensions

Cabled Models

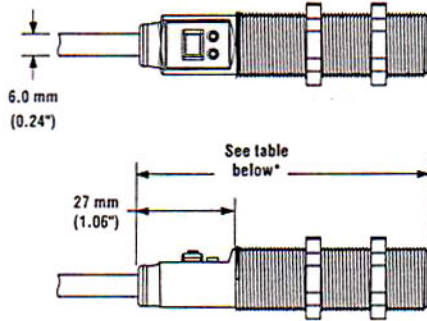

*Overall Length	
Model M18T88	81.2 mm (3.20")
Model M18T86E	81.7 mm (3.22")
Model M18T814	86.5 mm (3.41")

QD Models

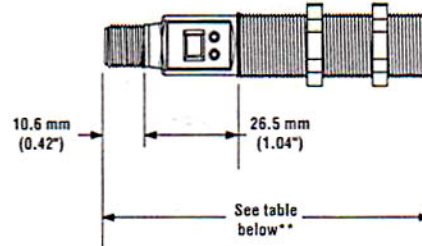

**Overall Length	
Model M18T88Q	91.3 mm (3.59")
Model M18T86EQ	91.8 mm (3.61")
Model M18T814Q	96.6 mm (3.80")

Hookups

Cabled Models

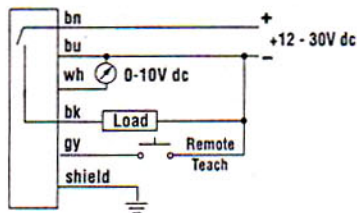

QD Models

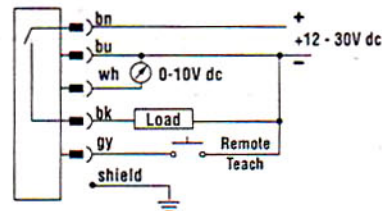

NOTE: It is recommended that the shield wire be connected to earth ground or dc common.



Accessories

Quick-Disconnect Cables



Style	Model	Length	Dimensions	Pinout
5-pin Euro-style straight, with shield	MQDEC2-506 MQDEC2-515 MQDEC2-530	2 m (6.5') 5 m (15') 9 m (30')		
5-pin Euro-style right-angle, with shield	MQDEC2-506RA MQDEC2-515RA MQDEC2-530RA	2 m (6.5') 5 m (15') 9 m (30')		

T-GAGE™ M18T Series Temperature Sensors – Analog Output

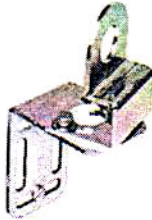
Accessory Mounting Brackets

<p>SMB18A</p>	<ul style="list-style-type: none"> • 12-gauge, stainless steel, right-angle mounting bracket with a curved mounting slot for versatility and orientation • Clearance for M4 (#8) hardware 	
<p>SMB18SF</p>	<ul style="list-style-type: none"> • 18 mm swivel bracket • Black thermoplastic polyester • Includes stainless steel hardware 	
<p>SMB18UR</p>	<ul style="list-style-type: none"> • 2-piece universal 18 mm swivel bracket • 300 series stainless steel • Includes stainless steel swivel locking hardware 	

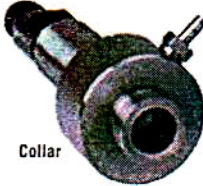
Accessories

<p>Air-Purge Collar APC-18</p>	<ul style="list-style-type: none"> • Positive air pressure prevents water, dust, and other airborne contaminants from collecting on the sensor face. • Air flow helps cool sensors affected by ambient heat in the sensing environment. • Works with many of Banner's 18 mm threaded-barrel photoelectric and temperature sensors. <p>NOTE: Because air temperature affects the speed of sound, the Collar should not be used with ultrasonic sensors.</p>	<p>Sensor not included</p>  <p>Collar</p>
<p>Laser Alignment Tool LAT1812</p>	<ul style="list-style-type: none"> • Enables easy sensor alignment at long distances. • Kit includes one SMB1812 bracket and M12 laser emitter. • Thread bracket housing onto barrel of mounted sensor; M12 laser emitter inserted into housing provides a precise laser spot for aiming temperature sensor. (Refer to Banner data sheet p/n 122529 for more information.) • Remove laser emitter before using sensor. 	<p>SMB1812 Bracket</p>  <p>M12 Laser Emitter</p>  <p>Shown with T-GAGE M18T attached</p>



WARRANTY: Banner Engineering Corp. warrants its products to be free from defects for one year. Banner Engineering Corp. will repair or replace, free of charge, any product of its manufacture found to be defective at the time it is returned to the factory during the warranty period. This warranty does not cover damage or liability for the improper application of Banner products. This warranty is in lieu of any other warranty either expressed or implied.

P/N 123698

Banner Engineering Corp., 9714 Tenth Ave. No., Minneapolis, MN USA 55441 • Phone: 763.544.3164 • www.bannerengineering.com • Email: sensors@bannerengineering.com